

Solutions to Accelerate Automation Modular Automation-Compatible Products

Modular

- Layout-Free Equipment ●Improved Efficiency
- High-Mix Low-Volume Production
- Reduce Labor Shortages ●Space Saving
- Energy Saving

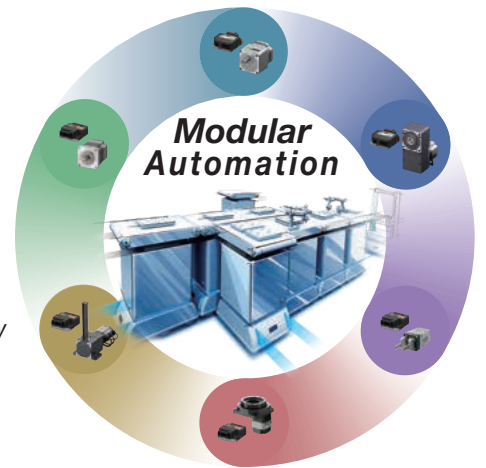

The Implementation of Layout-Free Automation Equipment and Lines is the Key to Flexibility Modular Automation-Compatible Products Support the Creation of Next Generation Automation

Companies need the flexibility to respond to changes in the external environment such as labor shortages, natural disasters and the constantly changing global situation. Production sites are increasingly adopting automation measures to replace humans for work such as transporting loads, working on production lines or doing work in difficult to access locations. In addition, the number of companies that are working to modularize equipment to allow line configurations to be reconfigured according to the situation is also increasing. The key to solving these issues is the creation of layout-free automation equipment and lines. Modular automation compatible products are a group of products that support the achievement of these goals.



The concept of flexible automation equipment and lines



- Use automated transportation instead of fixed conveyors
- The production line can be configured using modularized lightweight and compact equipment
- Eliminates the need to run AC power lines and extends range of movement

Elements necessary to achieve



"Battery drive & DC input" and "Light & compact"

Consider modular automation-compatible products

Modular Automation-Compatible Product Line

"Modular Automation Compatible Products" are a group of products based on the shared concept of battery operation, compact size and lightweight. Ideal for installation in self-propelled equipment and mobile facilities, they contribute to the creation of flexible automation lines and modular automation, which will see increasing demand in the future.

Brushless DC Motors BLV Series R Type

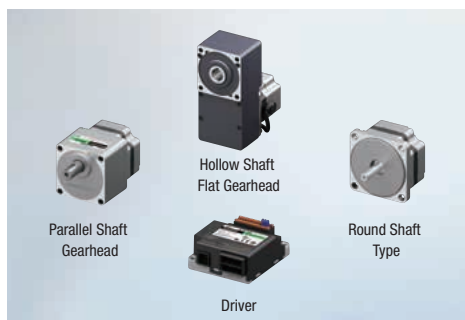

- Low-speed operation from 1 r/min can be performed. Provides smooth drive performance.
- Both the motor and driver are significantly smaller and lighter.
- Contributes to development of compact, battery driven devices.

αSTEP AZ Series mini Driver & Motors/Actuators

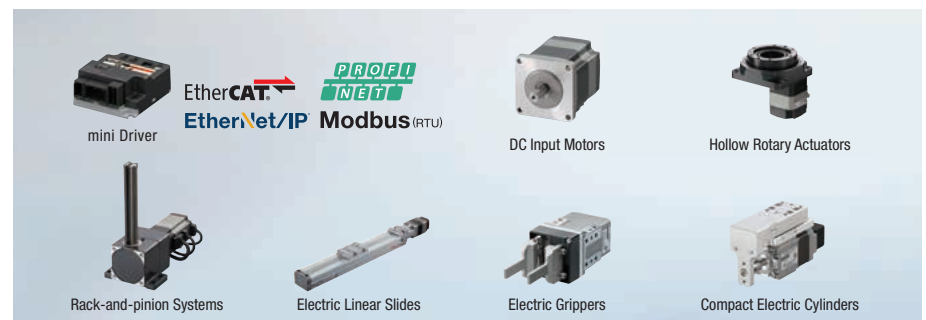

- Uses Oriental Motor's unique closed loop control.
- Equipped with the newly developed ABZO Sensor This makes an absolute system possible without a battery.
- The mini driver has been designed to be compact and lightweight to save control cabinet space in embedded applications. They can be connected to DC input motors and their on-board linear & rotary actuators. Contributes to the development of battery driven devices.

For Example, They Contribute to Following Layout-Free Projects:

Inter-Process Load Transporting Robots

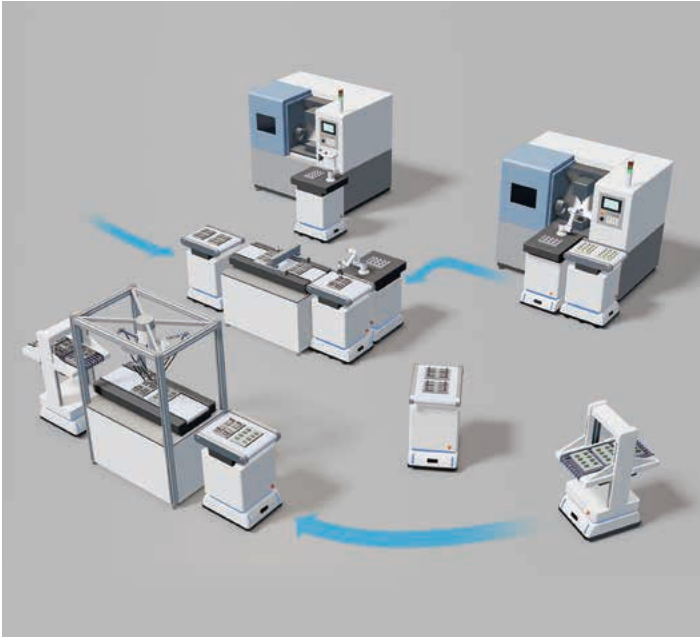

Articulated Arm Type
Transportation Robot

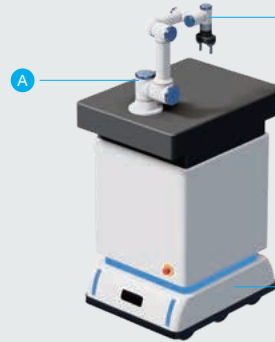

Vertical Articulated Robot A B

Drive for each joint:
AZ Series motor, mini Driver
Hand component:
Electric Gripper **EH** Series, mini Driver
Robot Controller **MRC01**

Lifting Equipment Type
Transportation Robot

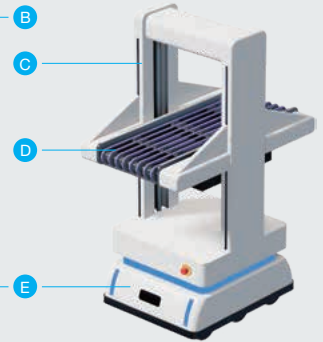

Lifting Equipment C
Rack-and-Pinion System **L** Series
Conveyor D
Transportation Robot (Wheel-Driven) E
BLV Series **R** Type

Flexible Modular Line That Can Be Reconfigured to Match the Product



X-Y-Z Type Modularized Equipment

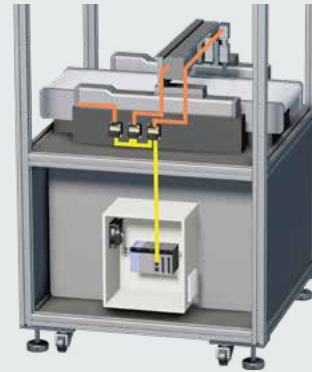

Distributed Driver Equipment

Distributed driver placement is possible thanks to the small size and light weight of the mini Driver. This allows for reduced wiring and smaller power distribution panels. Smaller, lighted equipment designs are possible.

Modular Automation-Compatible Products

Robot Controller **MRC01**

A robot controller that allows for easy setting, programming and operation of custom-built robots using the **AZ** Series. Compatible protocol: EtherNet/IP



DC Axial Flow Fans **MD** Series

24 VDC input axial flow fans adapted to ventilation and cooling Types: No alarm, with alarm, long life, speed control, waterproof



- EtherCAT® is a patented technology licensed from Beckhoff Automation GmbH (Germany) and is a registered trademark of that company.
- PROFINET is a trademark or registered trademark of PROFIBUS Nutzerorganisation e.V. (PNO).
- Modbus (RTU) is a registered trademark of Schneider Automation Inc. ● EtherNet/IP™ is a trademark of ODVA.
- **Orientalmotor**, **QSTEP**, and **ABZO Sensor** are registered trademarks or trademarks of Oriental Motor Co. in Japan and other countries.

Orientalmotor

Oriental Motor Asia Pacific Pte. Ltd.

2 Kaki Bukit Ave 1 #05-06
Singapore 417818
TEL: +65-6745-7344 FAX: +65-6745-9405
<http://www.orientalmotor.com.sg/>

Oriental Motor (Thailand) Co., Ltd.

Headquarters & Bangkok Office
63 Athenee Tower, 6th Floor Unit 603, Wireless Rd,
Lumpini, Pathumwan, Bangkok 10330, Thailand
TEL: +66-2-251-1871 FAX: +66-2-251-1872
<http://www.orientalmotor.co.th/>

Oriental Motor (India) Pvt. Ltd.

No.810. 8th Floor, Prestige Meridian-1 No.29,
M.G.Road, Bangalore, 560001, India
TEL: +91-80-41125586 FAX: +91-80-41125588
<http://www.orientalmotor.co.in/>

Oriental Motor (Malaysia) Sdn. Bhd.

Headquarters & Kuala Lumpur office
A-13-1, North Point Offices, Mid Valley City,
No.1 Medan Syed Putra Utara 59200
Kuala Lumpur, Malaysia
TEL: +60-3-22875778 FAX: +60-3-22875528

Penang office
1-4-14 Krystal Point II, Lebu Bukit Kecil 6,
Bayan Lepas 11900 Penang, Malaysia
TEL: +60-4-6423788 FAX: +60-4-6425788
<http://www.orientalmotor.com.my/>

For more information please contact: