

Standard AC Motors

Structure of Standard AC Motors

The basic structure of standard AC motors is shown below.

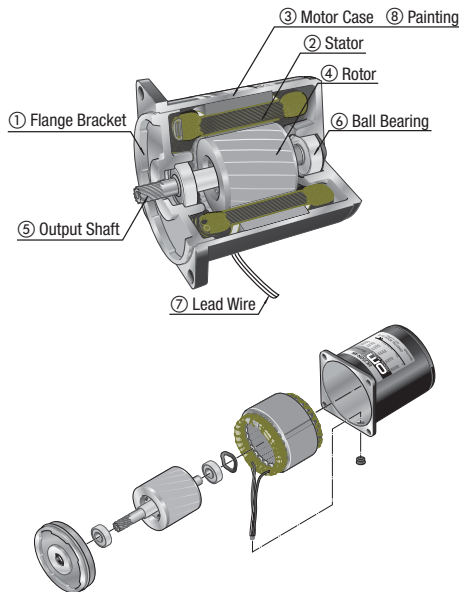

- ① Flange Bracket
The flange bracket is made by cutting/machining an aluminum alloy die cast block. The flange bracket is press fit into the motor case.
- ② Stator
The stator consists of the stator core made from laminated magnetic steel sheets, windings constituted by polyester-sheathed copper wire, and insulation film.
- ③ Motor Case
The motor case is made by cutting/machining an aluminum alloy die cast block.
- ④ Rotor
The rotor consists of laminated magnetic steel sheets and aluminum alloy die cast conductors.
- ⑤ Output Shaft
The round shaft type and pinion shaft type are available.
The material used is S45C, etc. The round shaft type is machined with a shaft flat (output power: 25 W or more), while the pinion shaft type is given precision gear cutting.
- ⑥ Ball Bearing
- ⑦ Lead Wire
The lead wire primarily uses heat-resistant polyethylene for the sheath.
- ⑧ Painting
Baking finish using acrylic resin or melamine resin is employed.

Brake Mechanism of Reversible Motors

Reversible motors have a simple brake mechanism (friction brake) at the rear of the motor. The brake mechanism is provided for the following purposes:

- Improve instantaneous reversibility by adding frictional load.
- Minimize overrun.

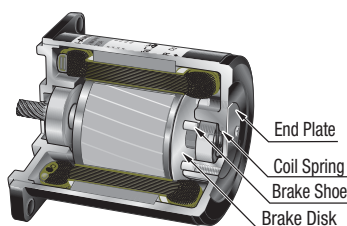

Structurally, the coil spring is used to constantly press the brake shoe against the brake disk to cause sliding, as shown in the figure above.

Although some holding force is generated, this type of structure has a limited braking force. For Oriental Motor products, the braking force of a reversible motor is assumed to be approximately 10% of the output torque of the motor.

Structure and Operation of Electromagnetic Brake

Electromagnetic brake type motors adopt power off activated type electromagnetic brake.

A representative example of an electromagnetic brake structure is shown below.

When voltage is applied to the magnetic coil, the armature is attracted to the electromagnet against the force of the coil spring thereby releasing the brake. As a result, the motor shaft rotates freely. In contrast, when voltage is not applied, the armature is pressed to the brake hub by the coil spring thereby applying the brake. As a result, the motor shaft is fixed.

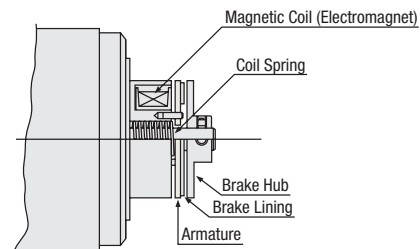

Overheat Protection Device

If a motor in operation is locked as a result of overload, ambient temperature rises rapidly, or when the input current increases for some reason, the motor temperature will rise abruptly. If left in this state, the performance of the insulation within the motor will deteriorate possibly shortening the service life of the motor or in an extreme case a fire may occur due to windings of the motor burning. To protect the motor from these thermal abnormalities, our motors, which are recognized by UL and CSA and conform to EN and IEC Standards, are equipped with the following overheat protection devices:

Thermally Protected Motors

Motors with a frame size of 70, 80, 90 or 104 mm square have a built-in thermal protector of automatic return type. The structure of this thermal protector is shown below.

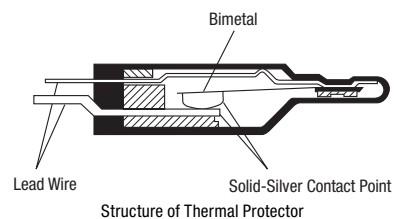

The thermal protector adopts the bimetal system, where the contact points use solid silver. It has an electrical resistance that is the lowest among all metals and a heat conduction that is second only to copper.

Operating Temperature of Thermal Protector

Open: $130 \pm 5^\circ\text{C}$

(The operating temperature may vary depending on the product.)

Closed: $82 \pm 15^\circ\text{C}$

(The operating temperature may vary depending on the product.)

(The motor winding temperature becomes slightly higher than the above operating temperature when the thermal protector is actuated.)

Impedance Protected

This measure is applied to motors whose frame size is 60 mm square or less. Impedance protected motors are designed with higher impedance in the motor windings so that even if the motor locks, the increase in current (input) is minimized and temperature will not rise above a certain level.

Capacitor

Our AC motors designed for single-phase power supply are all capacitor start and run motors. With capacitor start and run motors, the main winding and auxiliary winding are wound around the 90° polar axis in electrical angle. The capacitor is connected in series to this auxiliary winding to advance the phase of current flowing into the auxiliary winding.

For the motor, a vapor deposition electrode capacitor conforming to JIS C 4908 (Capacitors for Electrical Device) is mainly used. This type of capacitor uses plastic film of metal vapor deposition type for its component and is therefore self-healing. Accordingly, it is generally called a "SH (Self-Healing)" capacitor. Oriental Motor uses capacitors of the following type:

- Film capacitor, square resin case type
(Oriental Motor Product Name: CH capacitor)

Capacitance

If a capacitor with the wrong capacitance is used, vibration or heat generation in the motor may increase significantly or torque may drop making operation unstable. Be sure to use the capacitor that comes with the motor. The capacitor's capacitance is indicated in μF (microfarads).

Rated Voltage

If the rated voltage is exceeded, the capacitor may be damaged causing smoke or fire. Be sure to use the capacitor that comes with the motor. Rated capacitor voltage is indicated in V (volts). The rated voltage of the capacitor is marked on the surface of the capacitor case. Take note that this is different from the rated voltage of the motor.

Rated Conduction Time

The rated conduction time represents the minimum design life when the capacitor is operated at the rated load, rated voltage, rated temperature and rated frequency. As a guide, the rated conduction time will be 25,000 hours. If the capacitor is damaged near the end of its service life, smoke and fire may result. It is recommended that you replace the capacitor when the rated conduction time is reached.

Consider implementing protective measures to prevent the equipment from being affected should the capacitor present any abnormality.

Safety Feature of Capacitor

Some capacitors come with a safety feature so that even if the capacitor suffers a dielectric breakdown, it can be safely disconnected from the circuit to prevent smoke and fire. Oriental Motor's products utilize a capacitor with safety feature that has been recognized by UL Standards after passing the UL 810 failure current test at 10,000 A.

Speed – Torque Characteristics of Induction Motors

The graph below shows the speed-torque characteristics of induction motors.

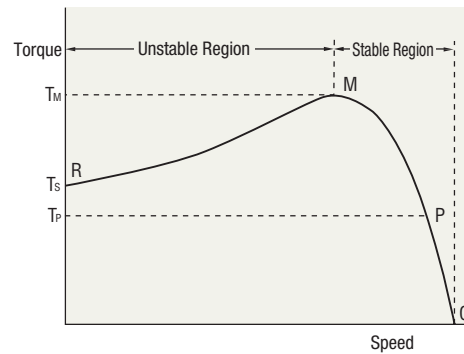

When no load is applied, the motor rotates at a speed near the synchronous speed. As the load increases, the speed gradually drops until the point P is reached where the load balances out with the motor torque T_P .

If the load increases further to point M, the motor cannot generate greater torque. As a result, point R is reached and the motor stops.

In other words, R – M represents an unstable range, while M – O is where the motor can be operated stably.

For your information, induction motors are available in two types including the capacitor start and run single-phase induction motor and the three-phase induction motor. With the single-phase type, the starting torque is generally smaller than the operating torque. With the three-phase type, the starting torque characteristics are relatively high.

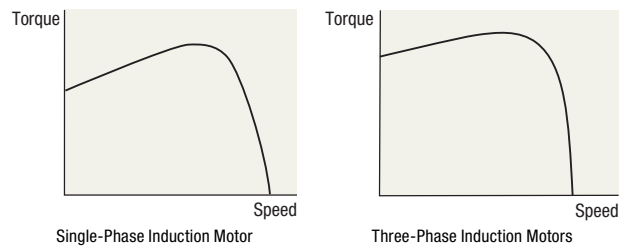

The motor generated torque changes roughly in proportion to the square of the power supply voltage. For example, assume that 110 VAC is applied to a motor whose rated voltage is 100 VAC. In this case, the motor generated torque becomes approximately 120%. In this condition, the motor temperature may rise above the permissible range.

On the other hand, when 90 VAC is applied, the generated torque becomes approximately 80%. In this condition, the motor may not operate as expected. For the above reasons, keep the power supply voltage within $\pm 10\%$ of the rated voltage because large fluctuations in the power supply voltage may cause the motor temperature to exceed the permissible range or the torque to drop thus making the operation unstable.

Speed – Torque Characteristics of Reversible Motors

Reversible motors are also capacitor start and run single-phase induction motors, just like standard induction motors, and therefore their speed – torque characteristics are the same as those of induction motors explained above.

The only difference is that with reversible motors, the starting torque is set larger to improve instantaneous reversibility compared to the induction motor.

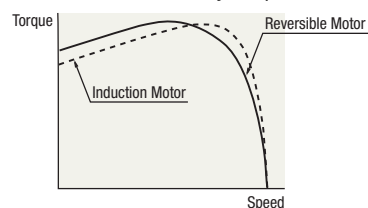

Overview of Torque Motors

- Torque can be adjusted by changing the voltage applied to the motor.
- Torque motors have a large starting torque, sloping characteristics and can be used over the entire range of their speed - torque characteristics.
- Stable torque is generated at low speed and in locked state, unlike induction motors and reversible motors.
- If the load is constant, the speed can be changed by adjusting the applied voltage.
- If the applied voltage is constant, the speed changes when the load changes.

Speed – Torque Characteristics of Torque Motors

With the **TM** Series torque motor and power controller packages, the applied voltage, and consequently the torque, can be changed by adjusting the torque setting voltage or each torque potentiometer.

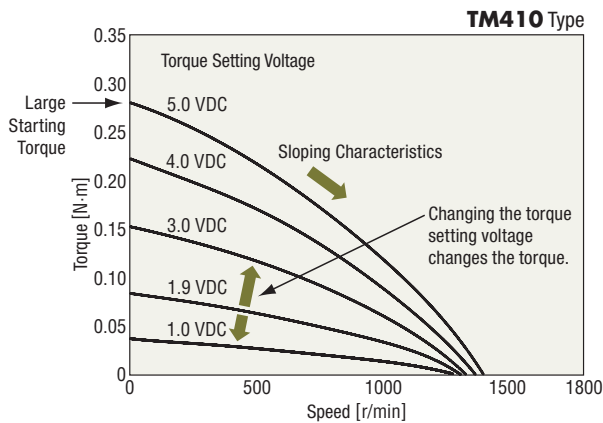

Torque motors can also generate a braking force when rotated in the opposite direction by an external force, etc. The brake characteristics of torque motors are called "reverse-phase brake." The range indicated by the normal speed – torque characteristics is called the duty region, while the range where the motor functions as a reverse-phase brake is called the braking area.

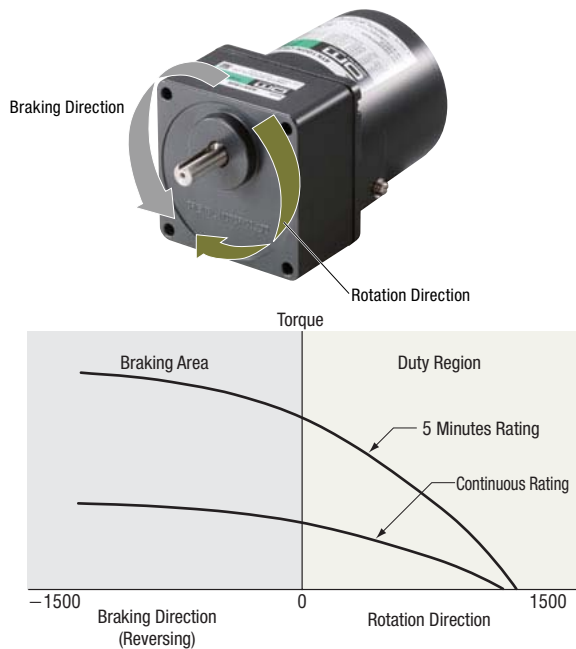

Temperature Rise in Standard AC Motors

Temperature Rise in Motors

When a motor is operating, all energy losses of the motor (iron loss and copper loss etc.) are transformed into heat, causing the motor temperature to rise.

- With induction motors (continuous rating), the temperature will stop rising and saturate at a certain level in 2 to 3 hours of operation.
- With reversible motors (30 minutes rating), the specified temperature will be reached in 30 minutes of operation and if the operation is continued, the temperature will rise further.

Measuring the Temperature Rise

At Oriental Motor, the temperature rise of each motor is specified based on the value measured by the method explained below.

Thermometer Method

A thermometer or thermocouple is affixed at the center of the motor case and the motor is operated in this condition to measure the saturated temperature, and the difference between this temperature and ambient temperature is defined as the temperature rise.

Resistance Change Method

Under this method, the winding temperature is measured based on resistance value change. The winding resistance and ambient temperature of the motor are measured using a resistance meter, thermostat, etc., before and after operation to calculate the rise in motor winding temperature.

Selection Calculations

Motors

Motorized Actuators

Cooling Fans

Service Life

Standard AC Motors

Speed Control Motors

Stepping Motors

Servo Motors

Gearheads

Linear Heads

Motorized Actuators

Cooling Fans

Operating Time and Temperature Rise of Reversible Motors

Although reversible motors have a "30 minutes rating," their operating time changes according to the operating conditions even when the motor is operated intermittently at short intervals. If a reversible motor is operated intermittently at short intervals, large current flows and generated heat increases when the motor is started or reversed. When the time during which the motor stays standstill is increased, however, the natural cooling effect increases and the motor temperature rise can be kept low.

Intermittent Operation

The conditions for intermittent operation are determined as A to E shown in figure 1. Condition F represents continuous operation. Temperature rise was measured on Oriental Motor's reversible motors under these conditions. The results are shown in figures 2 to 7.

The results are shown in figures 2 to 7.

When a temperature rise is measured, the standalone motor is suspended, and there is barely any heat conduction. Furthermore, in capacitor start and run motors, a rise in temperature is measured as the most severe no load condition.

Note, however, that the time needed to start or reverse the motor may increase and consequently the temperature will rise more if the load exceeds the rated torque of the motor or a large inertial load is applied.

With the **4RK25GN-CW2L2**, for example, you must make sure the rise in winding temperature is kept at 80°C or less and the motor case temperature at 90°C or less.

As shown in figure 4, the **4RK25GN-CW2L2** can be operated continuously in an intermittent mode as long as the operating time and stopping time are the same (conditions A and B). (C and D represent limit conditions.) Also note that the larger the motor output, the shorter the operable time becomes.

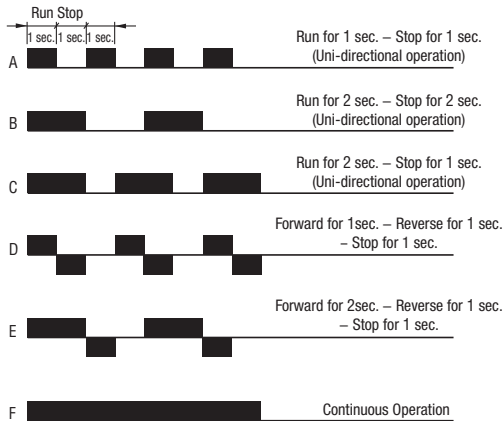

Figure 1 Operating Cycle

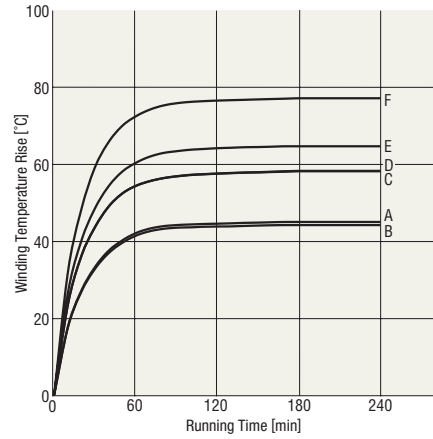

Figure 2 Intermittent Operation of **2RK6GN-CW2L2** (50 Hz, 220 VAC)

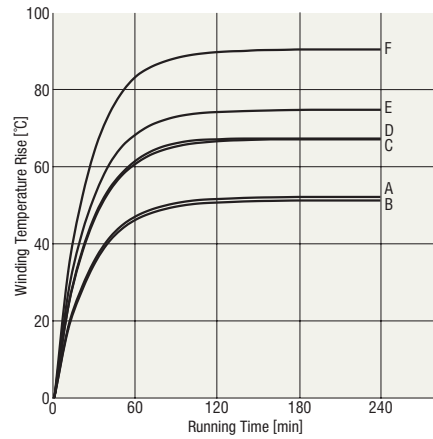

Figure 3 Intermittent Operation of **3RK15GN-CW2L2** (50 Hz, 220 VAC)

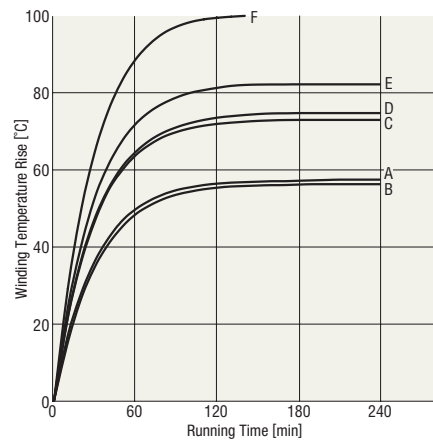

Figure 4 Intermittent Operation of **4RK25GN-CW2L2** (50 Hz, 220 VAC)

Heat Sink Installed

Table 2 lists the types of heat sinks used in the temperature rise measurement shown in figure 9.

From these measurement results, it is shown that when the size of the heat sink is doubled, the temperature rise can be lowered by approximately 10°C. It is also shown that, because aluminum has higher heat conduction than iron, the temperature rise is also smaller when an aluminum plate is used. When aluminum is coated black, the temperature rise decreases further by approximately 5°C.

The motor temperature varies depending on the load condition, operating cycle, how the motor is installed, ambient temperature, and so on. It is difficult to determine everything from data of these items alone, so this information should be used only as a reference.

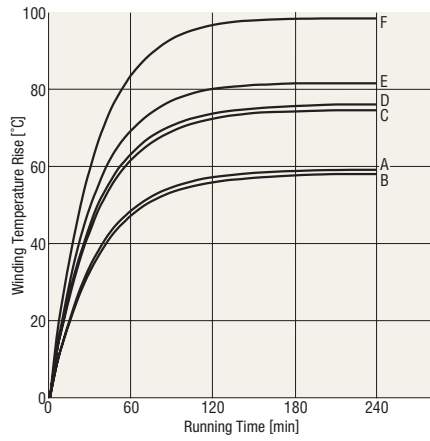

Figure 5 Intermittent Operation of **5RK40GN-CW2L2** (50 Hz, 220 VAC)

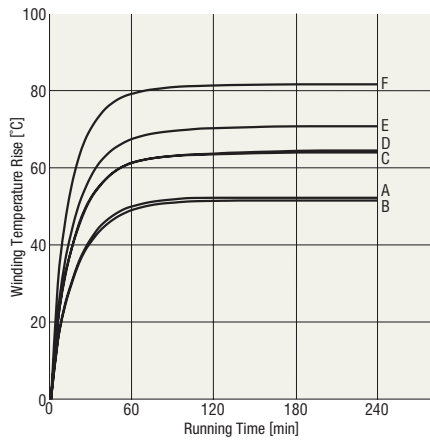

Figure 6 Intermittent Operation of **5RK60GE-CW2L2** (50 Hz, 220 VAC)

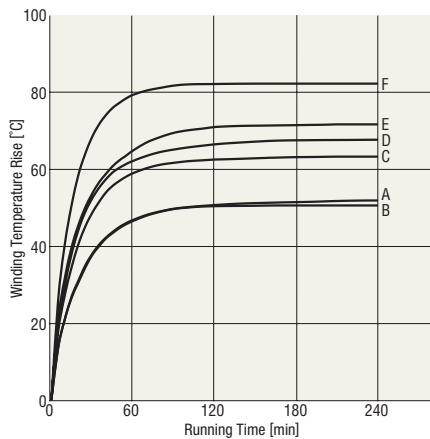

Figure 7 Intermittent Operation of **5RK90GE-CW3L2** (50 Hz, 220 VAC)

Table 1 lists the sizes of heat sinks used in the temperature rise measurements shown in figures 2 to 7.

Table 1: Sizes of Heat Sinks

Product Name	Size (mm)	Thickness (mm)	Material
2RK6GN-CW2L2	115×115	5	Aluminum
3RK15GN-CW2L2	125×125		
4RK25GN-CW2L2	135×135		
5RK40GN-CW2L2	165×165		
5RK60GE-CW2L2	200×200		
5RK90GE-CW3L2	200×200		

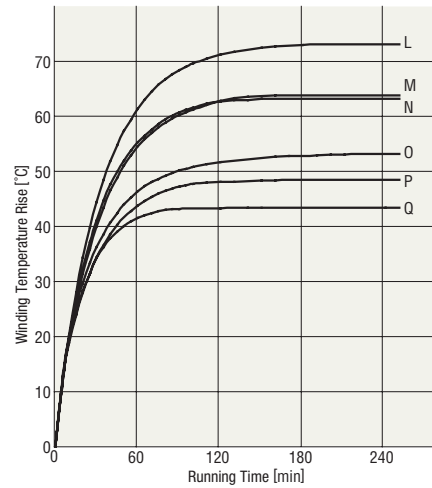

Figure 8 **4RK25** Type + Gearhead + Heat Sink
(The motor was installed with the gearhead and then installed on the heat sink.)

Table 2: Types of Heat Sinks

Temperature Rise Curve	Types of Heat Sinks			
	Size (mm)	Thickness (mm)	Material	Painting
L	—	—	—	—
M	150×150	5	Iron	None
N	150×150	5	Aluminum	None
O	300×300	5	Iron	None
P	300×300	5	Aluminum	None
Q	300×300	5	Aluminum	Black

Glossary

● Rating

◇ Rating

The rating refers to the limit of use below which operation of the motor is guaranteed based on temperature, mechanical strength, vibration, efficiency and other dynamic performance aspects. A rating can be a continuous rating or short time rating. The limit of use at a given output is determined under a given set of conditions, and the applicable voltage, frequency, speed, etc., are specified. They are called the "rated output power," "rated voltage," "rated frequency," "rated speed," etc.

◇ Continuous Rating and Limited Duty Rating

Time rating indicates the time during which the motor can continue operating at the rated output power without presenting abnormality. A continuous rating means that the motor can be used continuously at the rated output power, while a limited duty rating means that the motor can be operated at the rated output power only for the specified period.

● Output Power

◇ Output Power

Output Power represents the work that can be performed by the motor in the unit time, and is determined by the speed and torque of the motor. The rated output power value is marked on each motor. Output power is expressed in watts in Japan, but HP is used in Europe and the U.S.

$$\text{Output Power [W]} = 1.047 \times 10^{-1} \times T \times N$$

$$1 \text{ HP} = 746 \text{ W}$$

$$1.047 \times 10^{-1} : \text{Constant}$$

$$T \text{ [N}\cdot\text{m]} : \text{Torque}$$

$$N \text{ [r/min]} : \text{Speed}$$

◇ Rated Output Power

Rated output power is the output continuously generated by the motor while producing its best characteristics at the rated voltage and rated frequency. The speed and torque at which the rated output power is generated is called the "rated speed" and "rated torque," respectively. In general, the term "output power" means "rated output power."

● Torque

◇ Starting Torque

Starting torque is the torque generated by the motor the moment it is started. If the motor is suppressed by a frictional load greater than this torque, the motor will not turn. It is also called the starting torque. ①

◇ Stall Torque

The stall torque is the maximum torque that can be generated by the motor at a given voltage and given frequency. The motor stops once a load greater than this torque is applied. ②

◇ Rated Torque

Rated torque is the torque at which the motor generates the rated output power continuously at the rated voltage and rated frequency. It represents the torque at the rated speed. ③

◇ Static Friction Torque

Static friction torque is the torque generated when the load is held by the electromagnetic brake, clutch brake, etc., in a standstill state.

◇ Permissible Torque

Permissible torque is the maximum torque that can be used during motor operation. The permissible torque is limited by the rated torque and temperature rise of the motor as well as the strength of the combined gearhead.

Speed - Torque Characteristics

- ①: Starting Torque
- ②: Stall Torque
- ③: Rated Torque
- ④: Synchronous Speed
- ⑤: No Load Speed
- ⑥: Rated Speed

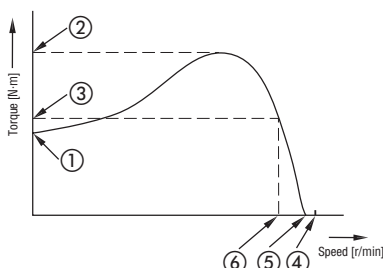

● Speed

◇ Synchronous Speed

Synchronous speed is uniquely determined by the number of motor poles and power supply frequency and expressed by the formula below:

Normally the synchronous speed is indicated by a speed per minute. ④

$$N_s = \frac{120f}{P} \text{ [r/min]}$$

$$N_s : \text{Synchronous Speed [r/min]}$$

$$f : \text{Frequency [Hz]}$$

$$P : \text{Number of Poles}$$

$$120 : \text{Constant}$$

For example, the synchronous speed of a 4-pole motor is calculated as follows if the power supply frequency is 50 Hz:

$$N_s = \frac{120 \times 50}{4} = 1500 \text{ [r/min]}$$

◇ No Load Speed

No load speed is the speed when no load is applied. With induction motors and reversible motors, the no load speed is several percent (approximately 20 to 60 r/min) lower than the synchronous speed. ⑤

◇ Rated Speed

Rated speed is the speed at which the motor generates its rated output power, and represents the most ideal speed for using the motor. ⑥

◇ Slip

Slip is one way of expressing speed and is expressed by the formula below:

$$S = \frac{N_s - N}{N_s} \text{ or } N = N_s (1 - S)$$

$$N_s : \text{Synchronous Speed [r/min]}$$

$$N : \text{Speed under Given Load [r/min]}$$

Here, a 4-pole, 50 Hz induction motor is operated at a slip S of 0.1. The speed can be calculated as below:

$$N = \frac{120 \times 50}{4} (1 - 0.1) = 1500 (1 - 0.1) = 1350 \text{ [r/min]}$$

● Overrun

Overrun is the number of excess rotation the motor makes that occur the moment the power is turned off until the motor stops, indicated by angle (number of rotations).

● Gearhead

◇ Gear Ratio

Gear ratio is the ratio at which the gearhead reduces the motor speed. The motor speed becomes $\frac{1}{\text{gear ratio}}$ on the gearhead output shaft.

In order to align the speed of the gearhead output, depending on whether the motor speed difference is at 50 Hz or 60 Hz, gearhead gear ratios are in a group of 3, 5, 7.5, 12.5, 15, ... and also a group which is 1.2 times these gear ratios of 3.6, 6, 9, 15, 18, and so on.

The speed of the gearhead output shaft can be made roughly identical when the gear ratio is 3 in the 50 Hz region, or 3.6 in the 60 Hz region.

All gearheads can be used in both the 50 Hz region and 60 Hz region.

◇ Maximum Permissible Torque

Maximum permissible torque is the maximum load torque that can be applied to the gearhead.

The maximum permissible torque is determined by the materials and sizes of gears and bearings used for the gearhead and other mechanical strength factors, which means that it varies depending on the type of gearhead and gear ratio used.

◇ Service Factor

Service factor is the coefficient used to estimate the gearhead life. Service factors are empirical values determined from life tests, etc., conducted under different types of loads and operating conditions.

◇ Transmission Efficiency

Transmission efficiency is the efficiency with which the torque is transmitted when the gearhead is connected to the motor. It is indicated in % (percent). The transmission efficiency is determined by the frictions of bearings and gears used for the gearhead, resistance of lubricants, and so on. Let us take the **GN** gearhead as an example. The transmission efficiency of this gearhead is considered 90% per each gear stage, so with the 2-stage type that has the least number of gear stages, the transmission efficiency will be 81%. The higher the gear ratio, the more gear stages there will be and consequently the transmission efficiency drops to 73%, 66%, and so on, according to the gear stages.

◇ Overhung Load

Overhung load is the load applied to the gearhead output shaft in the perpendicular direction. The maximum value of overhung load permitted on the gearhead is called the "permissible overhung load," which varies depending on the type of gearhead and distance from the shaft end. Overhung load corresponds to tension in belt drive.

◇ Thrust Load

Thrust load is the load applied to the gearhead output shaft in the axial direction. The maximum value of thrust load permitted on the gearhead is called the "permissible thrust load," which varies depending on the type of gearhead.

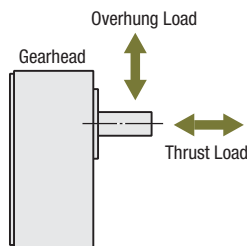

● Others

◇ CW, CCW

CW and CCW indicate the rotation directions of the motor. CW represents clockwise rotation as viewed from the output shaft, while CCW represents counterclockwise rotation.

Selection Calculations

Motors

Motorized Actuators

Cooling Fans

Service Life

Standard AC Motors

Speed Control Motors

Stepping Motors

Servo Motors

Gearheads

Linear Heads

Motorized Actuators

Cooling Fans